

Item	Description	Qty
A	Rear Shock Bracket Brace	1
B	Front Shock Bracket	1
C	Rear Shock Bracket	2
D	Shock Bracket Base, Right	1
E	Shock Bracket Base, Left	1

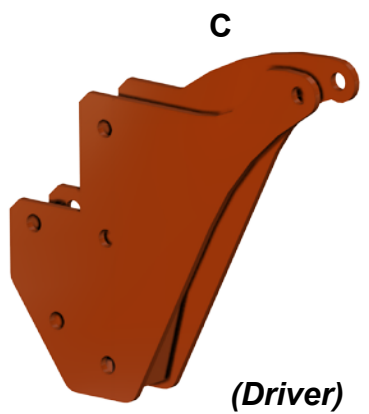
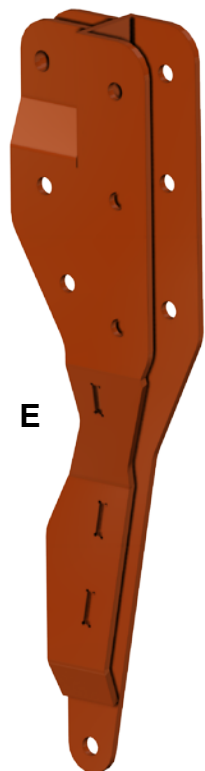
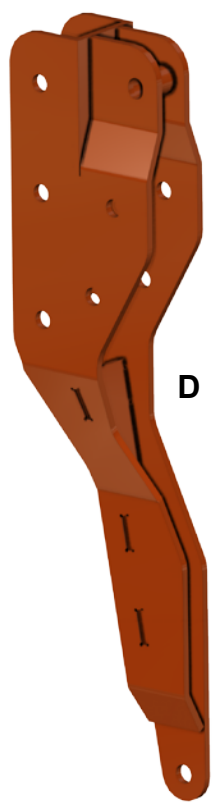
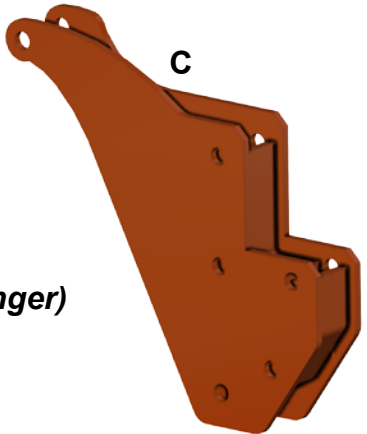
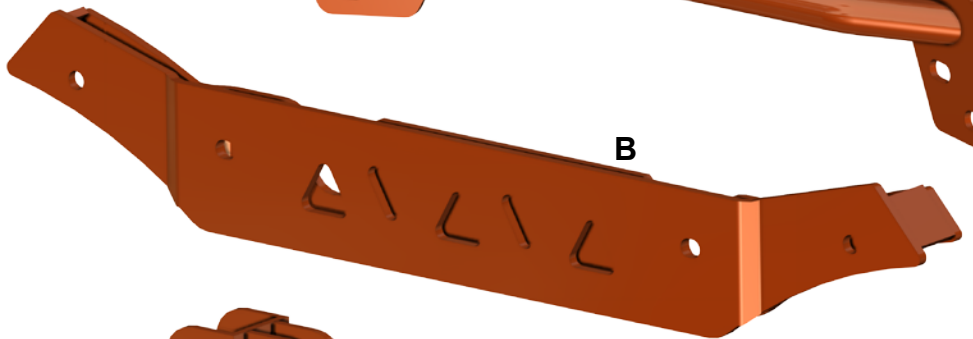
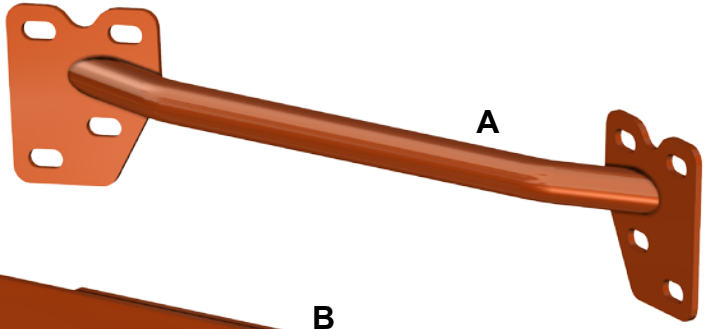

Steering Stop Kit

(Kit contents continue on following page)

Need help with your installation?

 sales@superatv.com
 www.superatv.com

 1-855-743-3427
  8:00am - 9:00pm EST M-Th
 8:00am - 7:00pm EST Friday
 9:00am - 2:00pm EST Saturday

Read instructions and view illustrations before beginning.

Thank You
For Choosing
SUPERATV.COM[®]

(Kit contents continued)

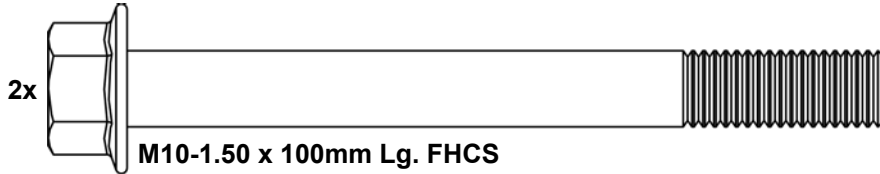
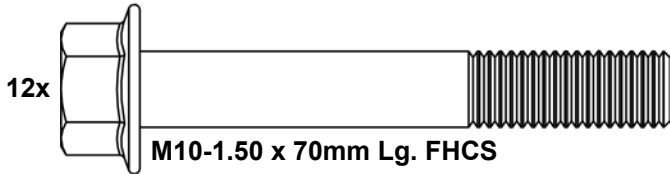
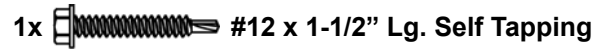

Front components shown must be removed; *Keep all components removed from machine.*

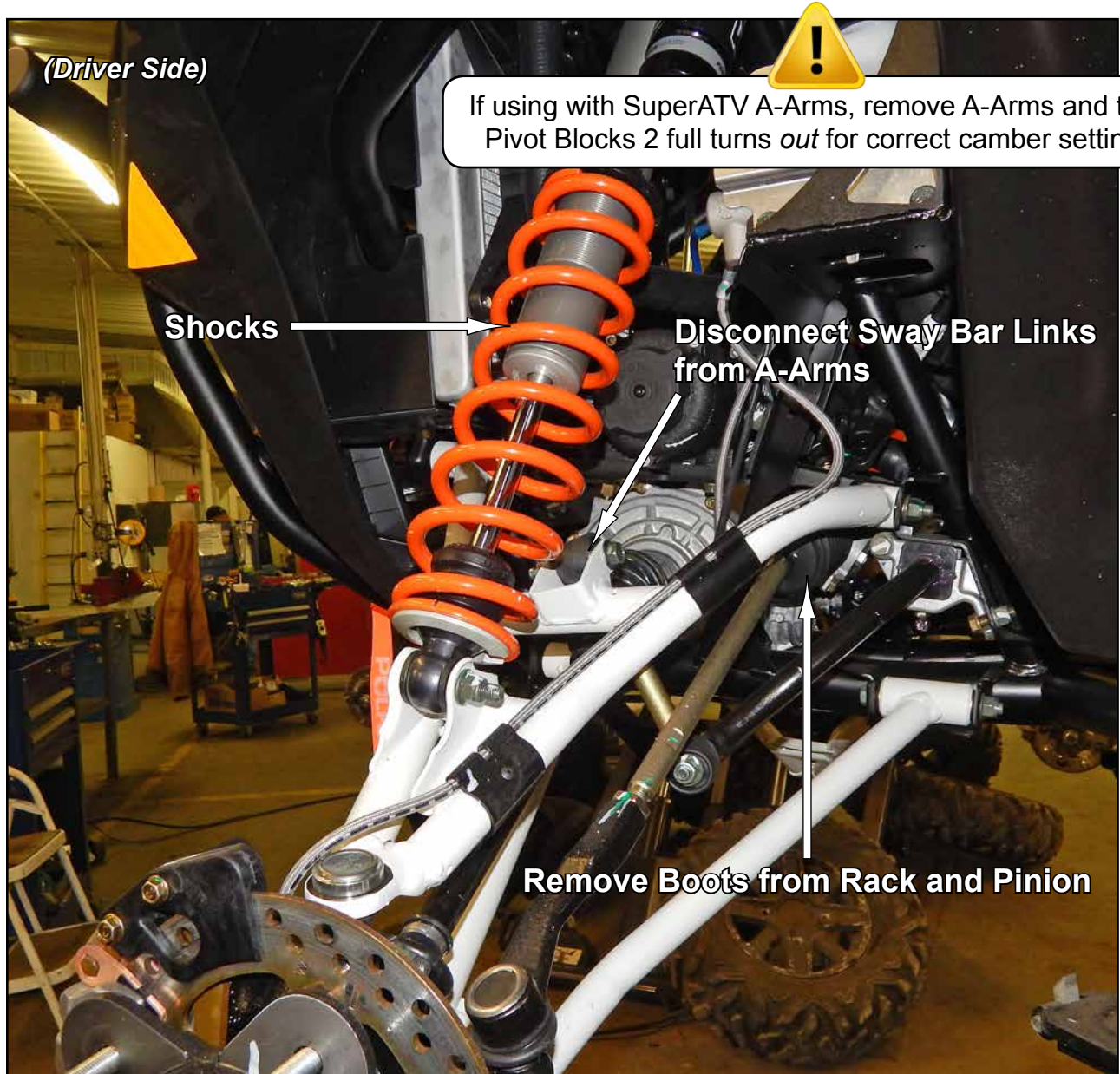

Wire Harness':

- Remove Wire Harness' from Shock Mount and components.
- Reroute and connect after Front Bracket has been installed.

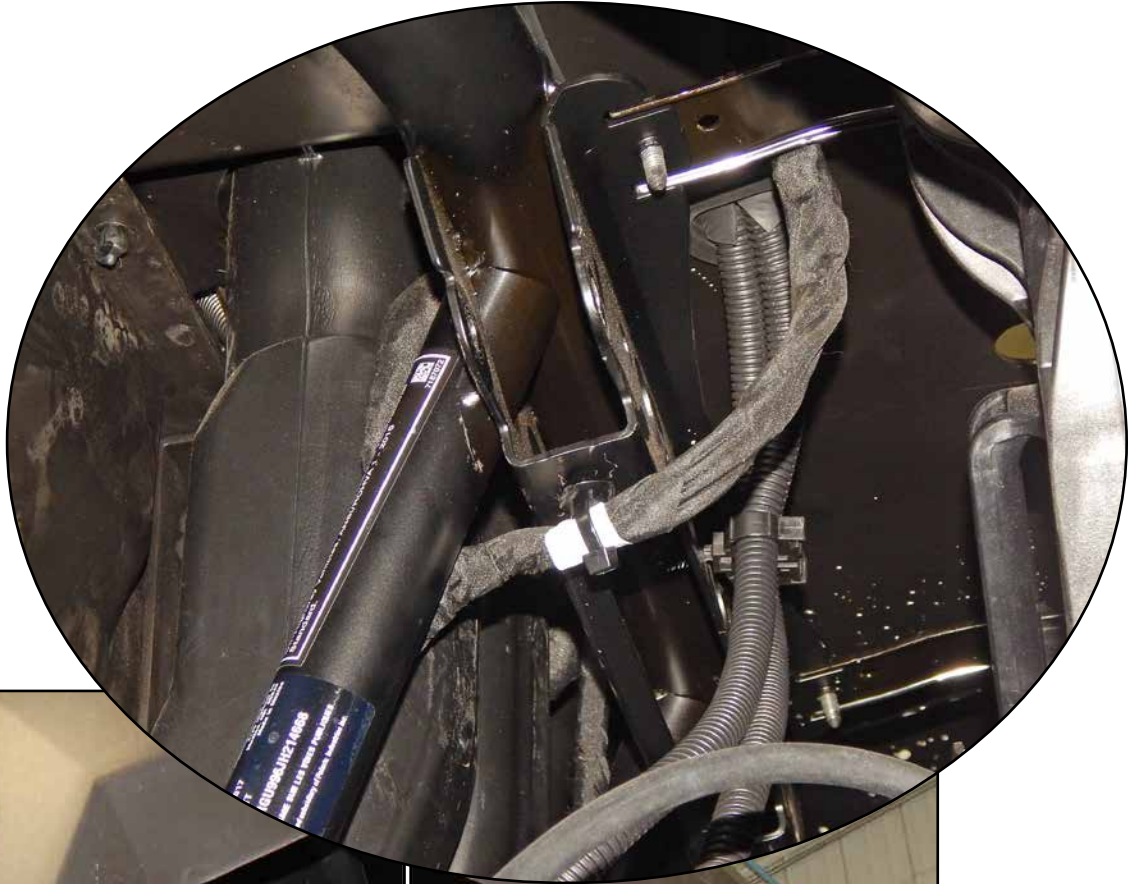

Vent Tube:

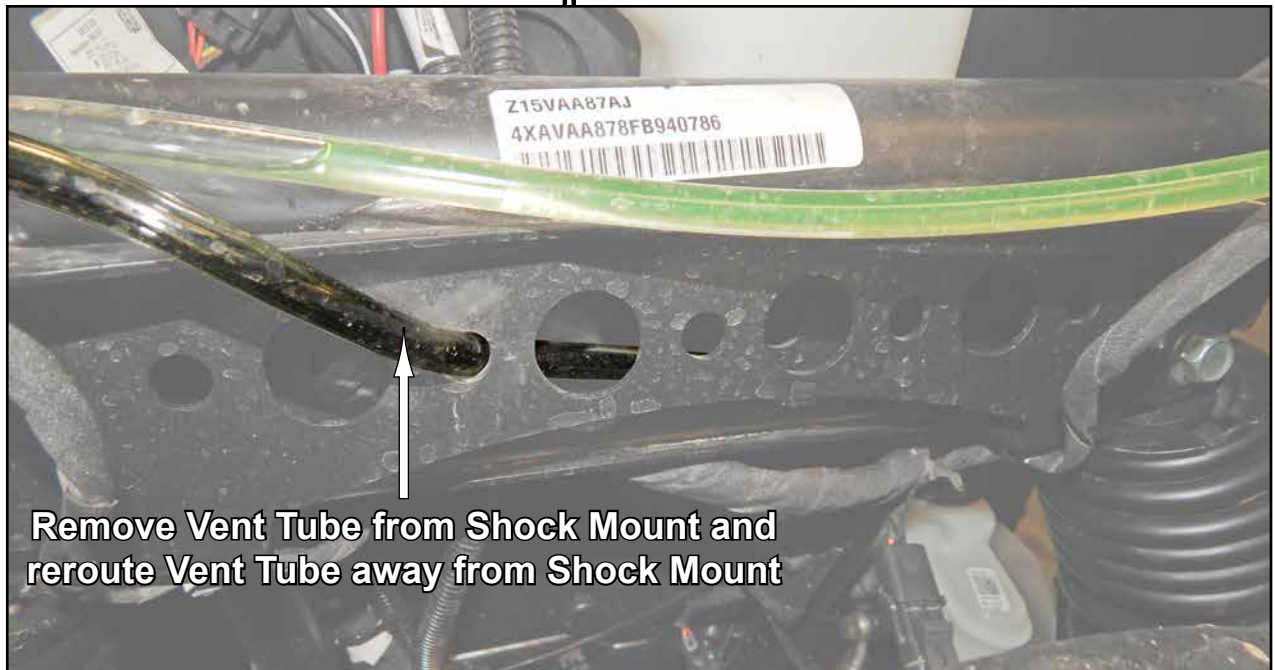
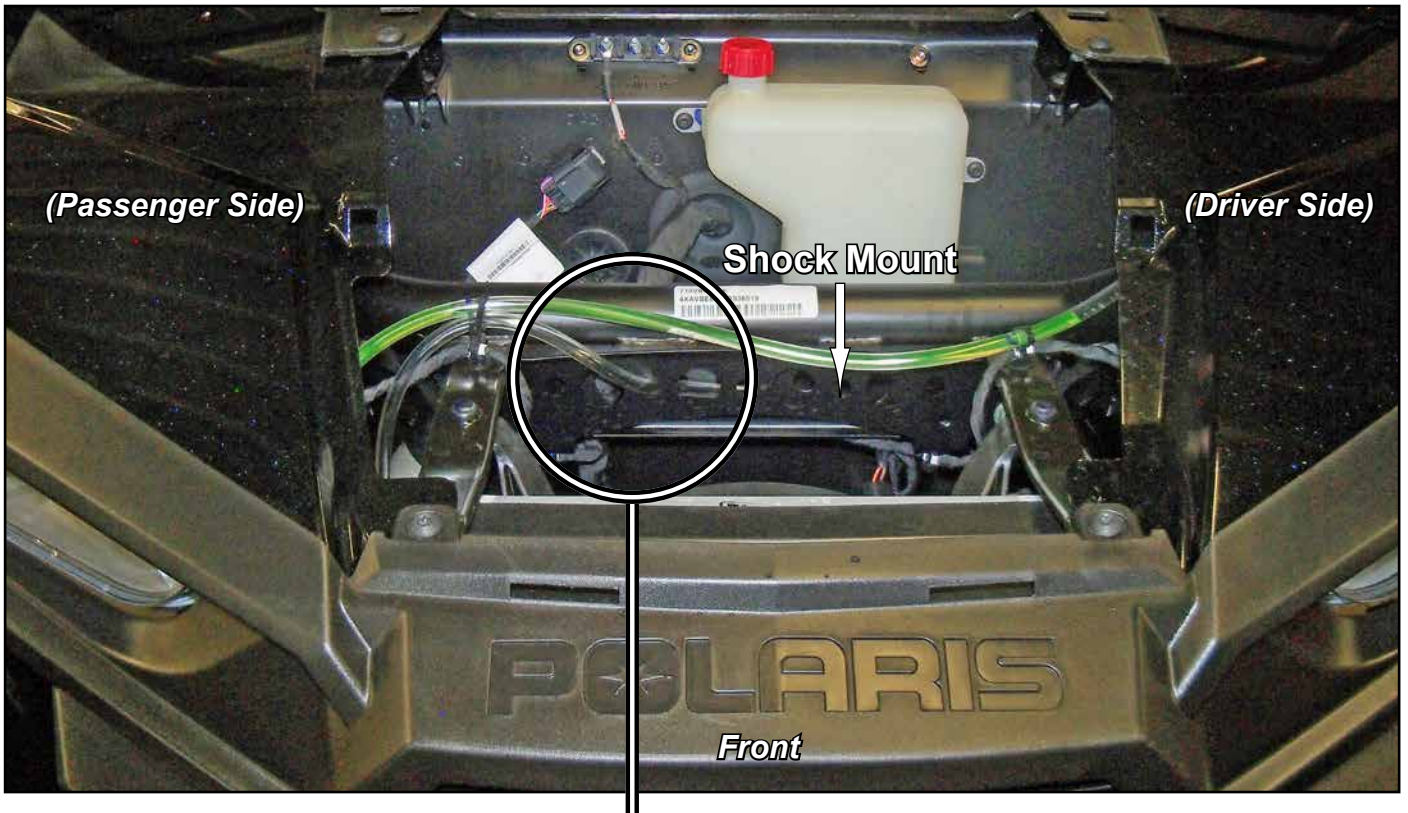

Rear components shown must be removed; Keep all components removed from machine.

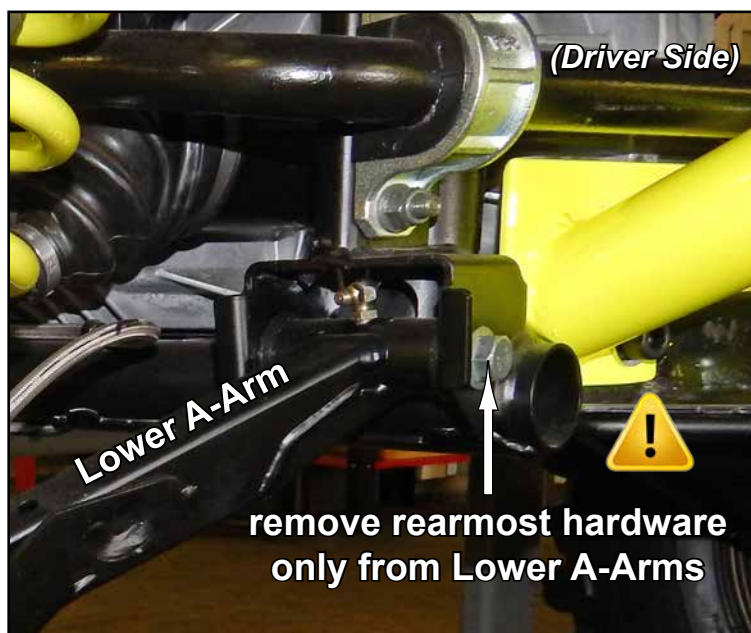
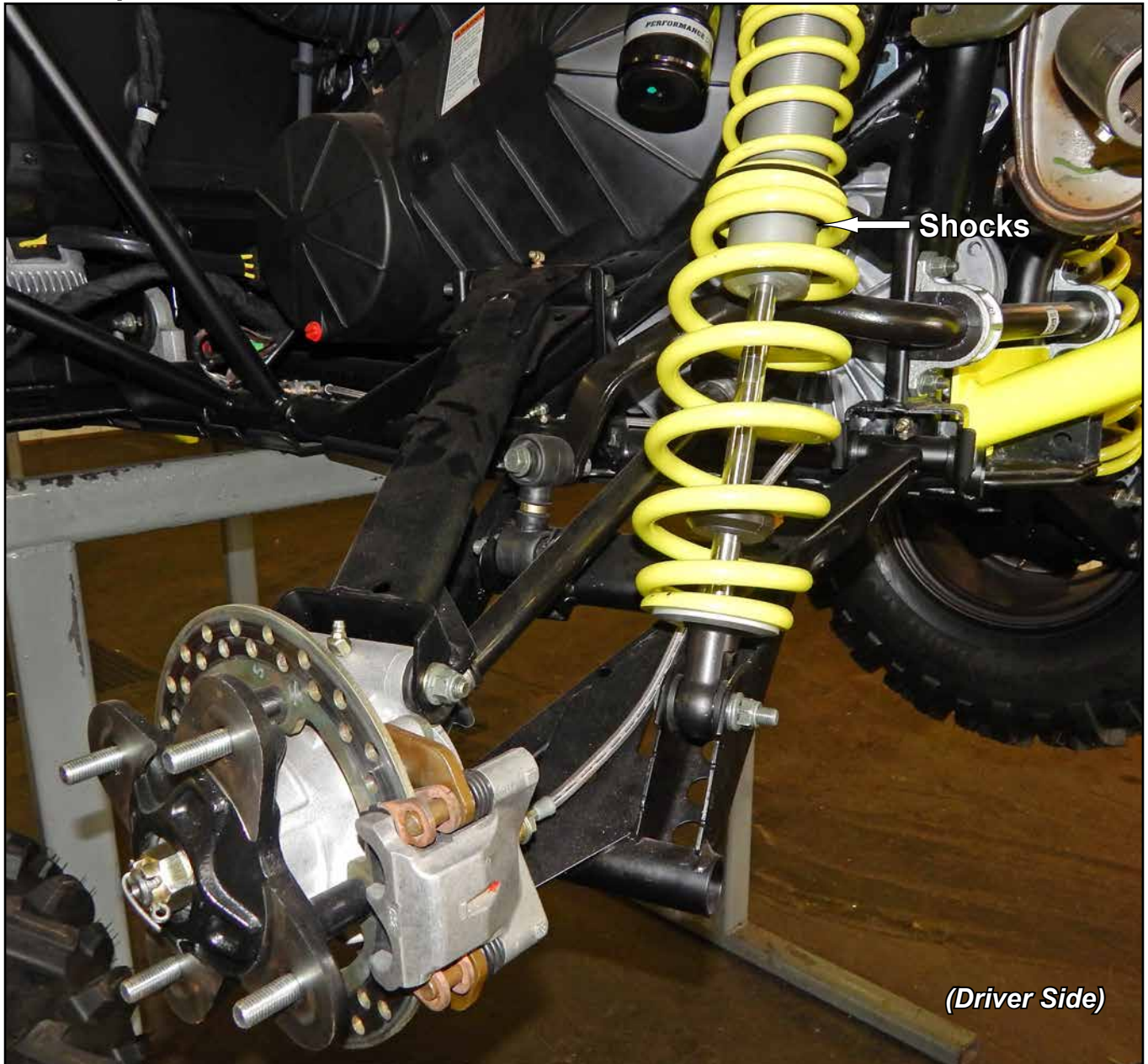

If present, relocate Relay.

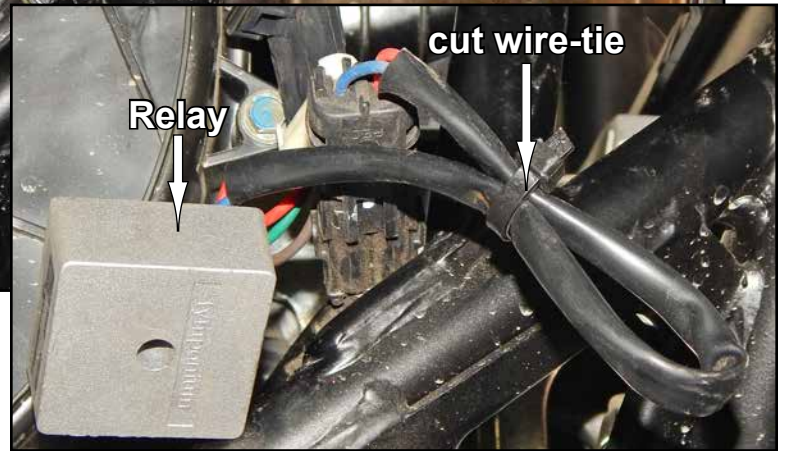
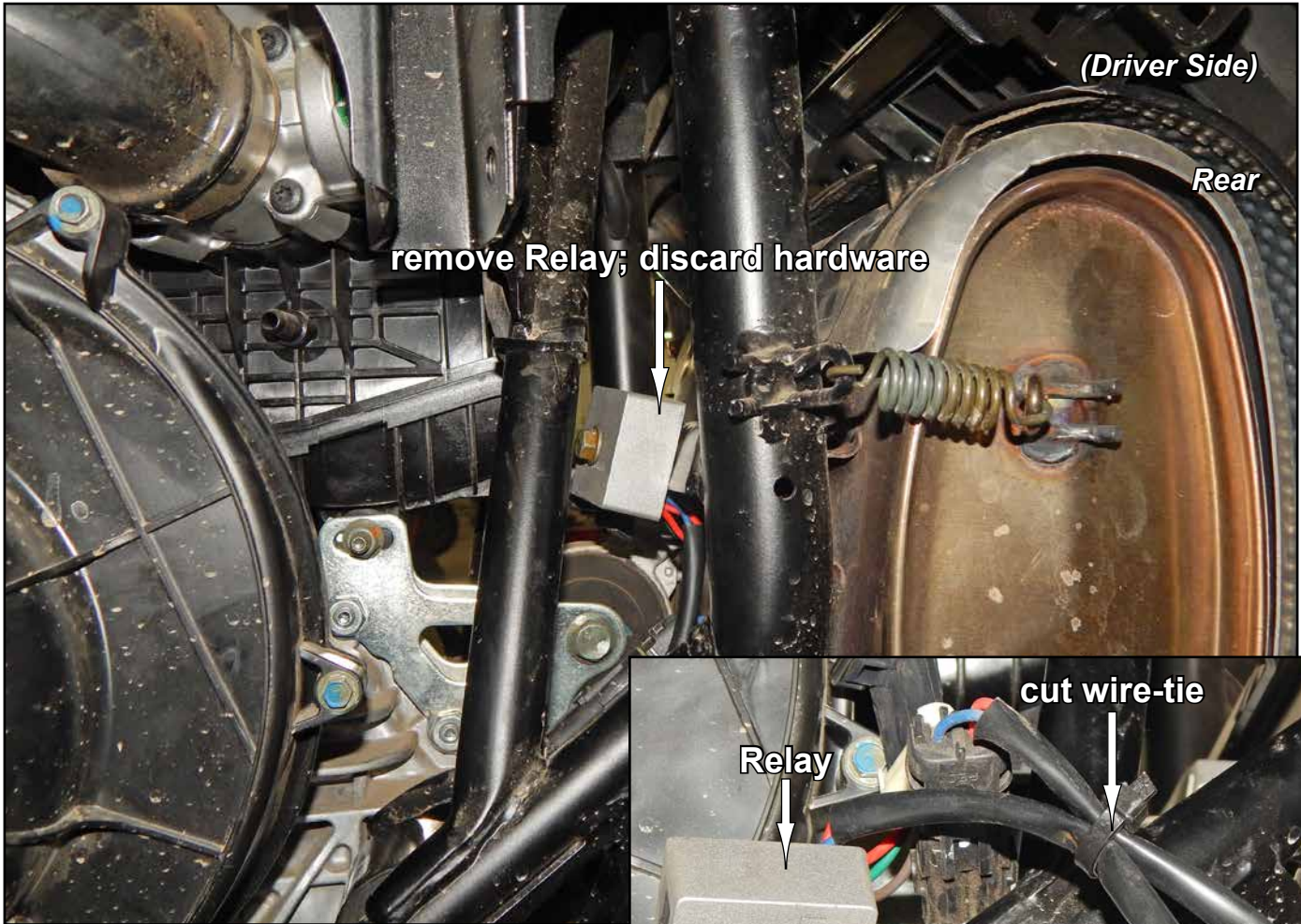



Remove any previously installed Steering Stops. Provided Steering Stops must be installed.

Steering Stop Installation: *Rack and Pinion shown off machine for clarity*

Note: Driver Side installation is shown.

- Install Bushing onto Rack and Pinion shaft; repeat for opposite side.
- Reinstall Boots to Rack and Pinion.

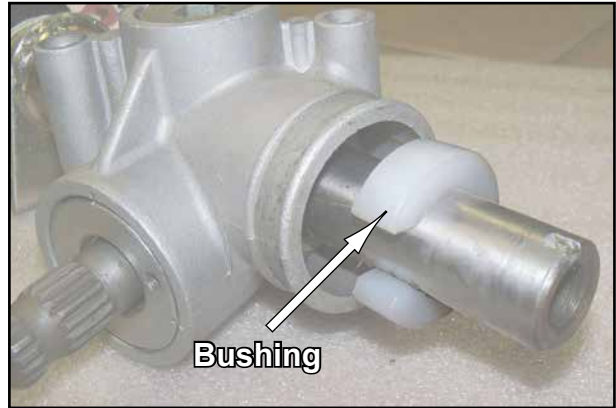
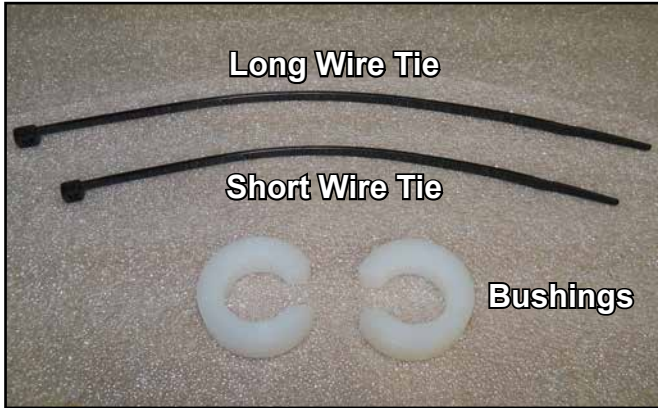

Rear Assembly Reference; *do not completely assemble at this time*

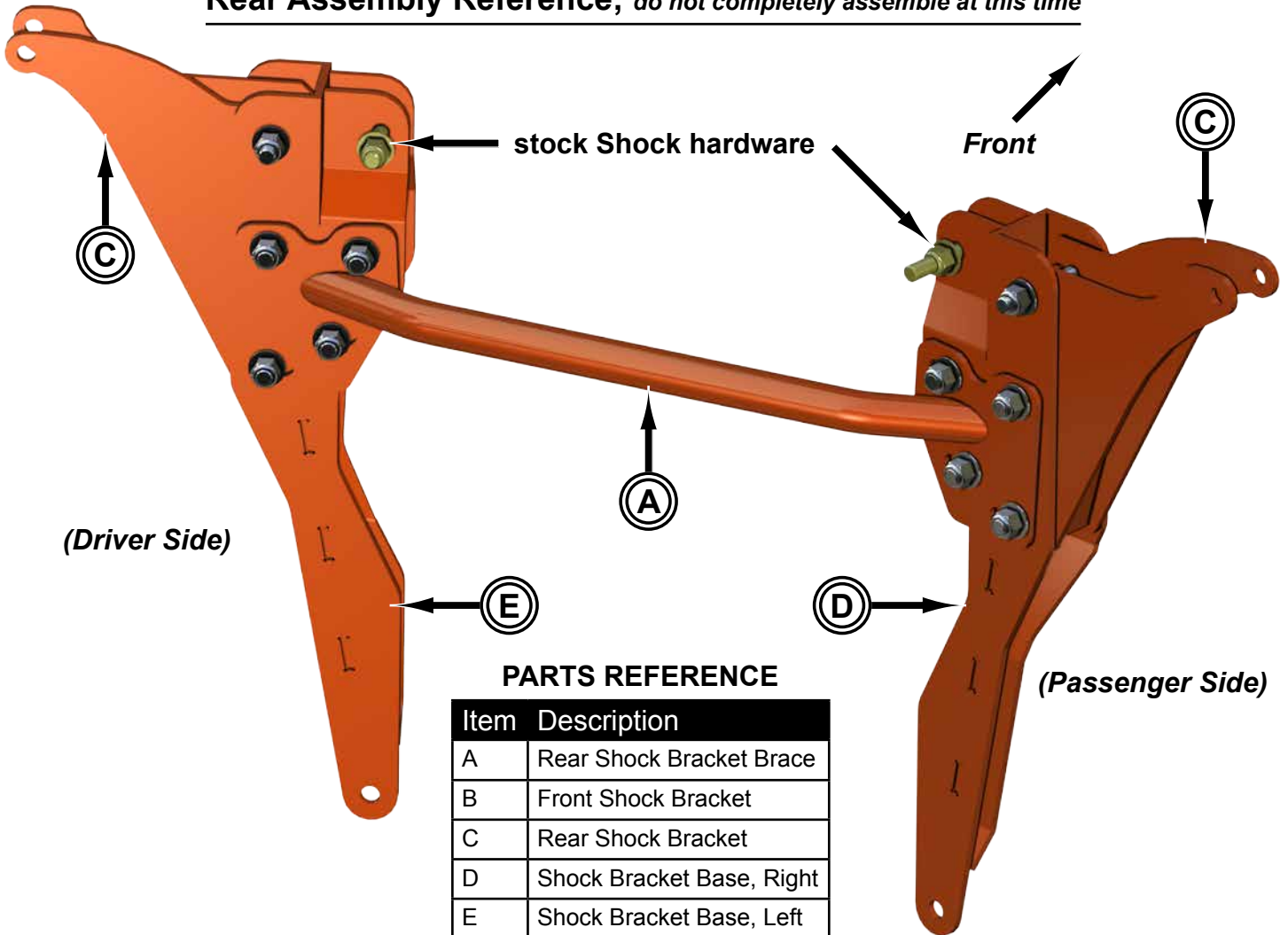

(Rear installation illustrations continue on following pages)

Rear Installation: *Do not tighten hardware completely until last step.*

- Install Shock Bracket Base, Left (E) into stock Shock Mount with stock Shock hardware.

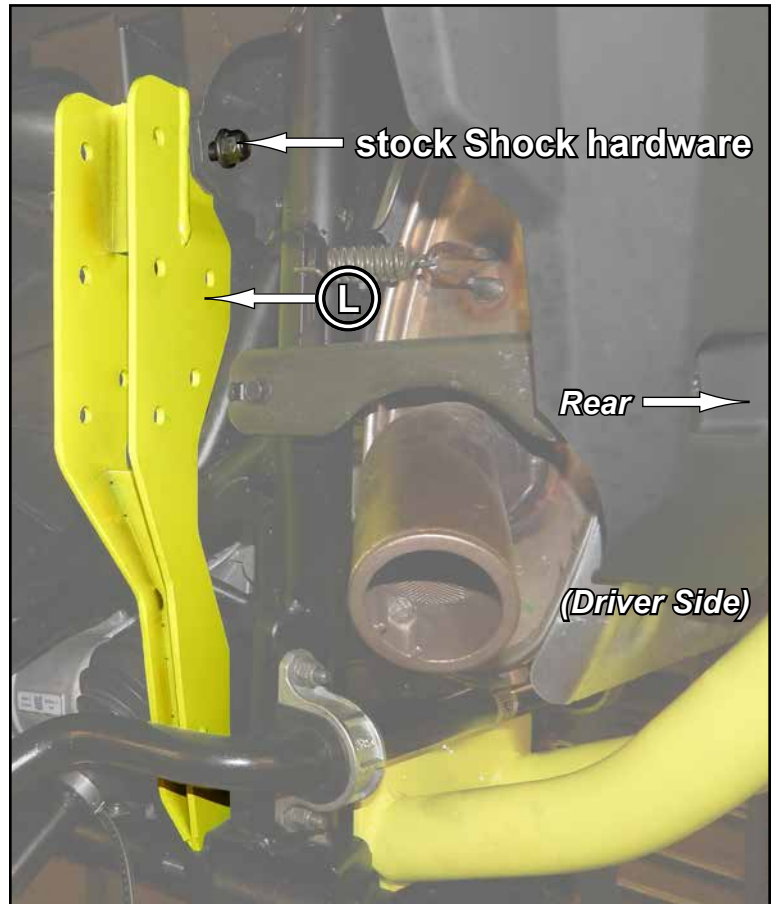
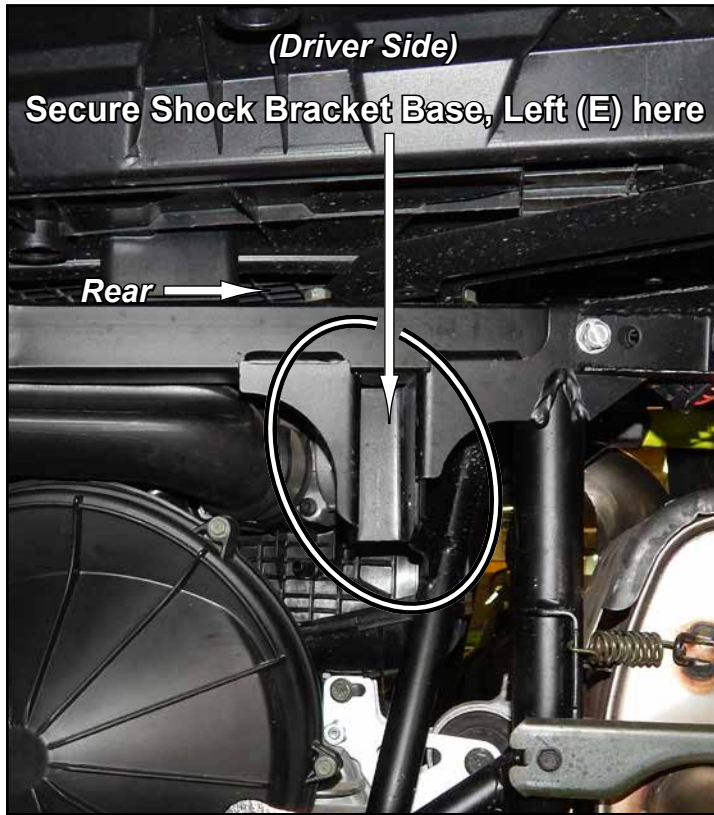

- Install hardware shown to rear portion of Lower A-Arms; **do not add Nylock Nut at this time.**
- Place lower hole in Shock Bracket Base, Left (E) onto previously installed hardware; **secure with Nylock Nut shown.**

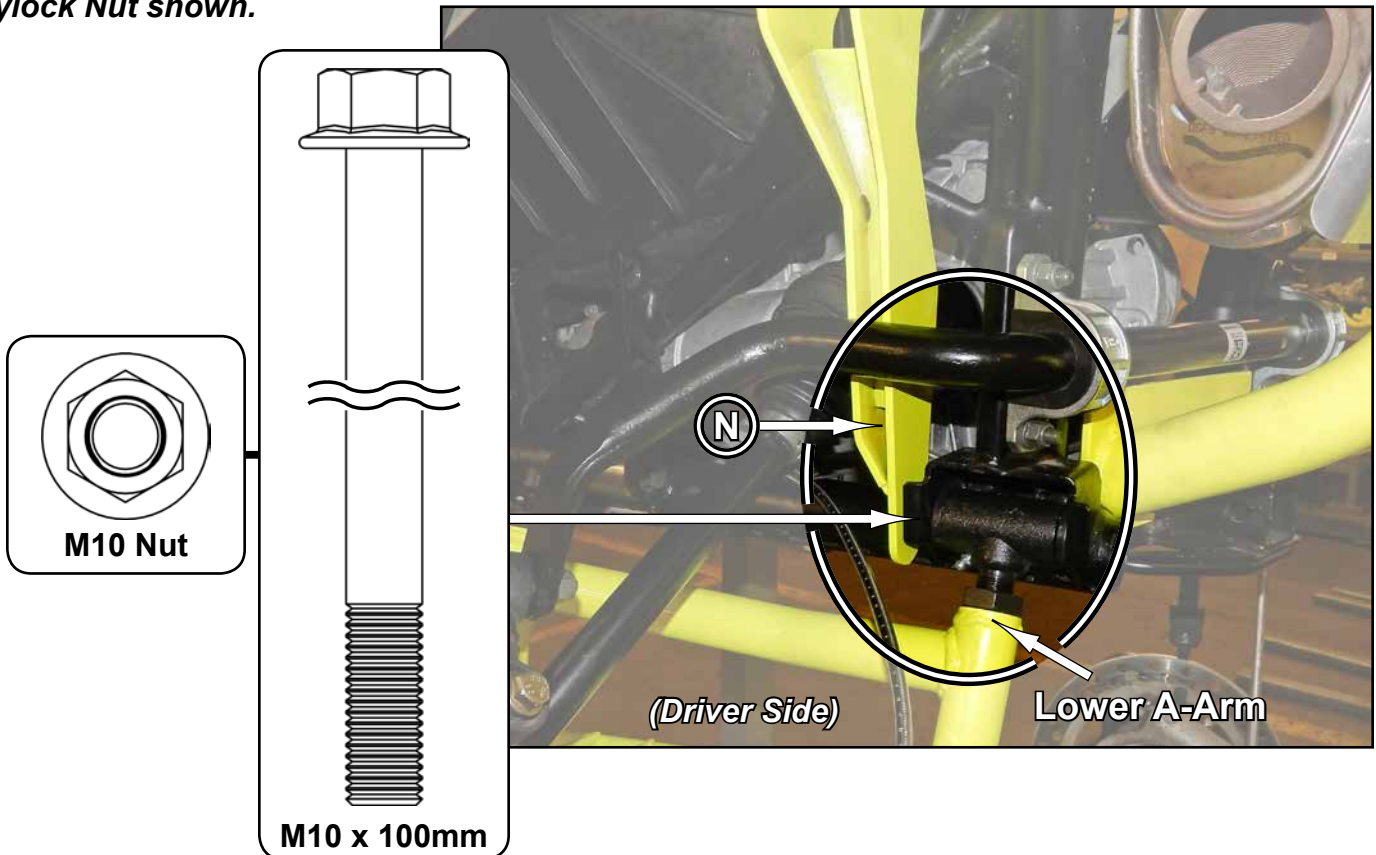

Rear Installation continued:

- Insert Rear Shock Bracket Brace (A) through Frame from opposite side.
- Install Shock Bracket (C) into Shock Bracket Base, Left (E).
- Secure Shock Bracket (C), Shock Bracket Base, Left (E), and Rear Shock Bracket Brace (A) with hardware shown.
- Repeat for Shock Bracket Base, Right (D).
- Reinstall Shocks with hardware shown:
 - **Install driver side to passenger side and vice versa if machine is equipped with FOX Shocks.**
 - **Flip Polaris shocks end-to-end when installing.**
 - **Walker Evans shocks will reinstall normally.**

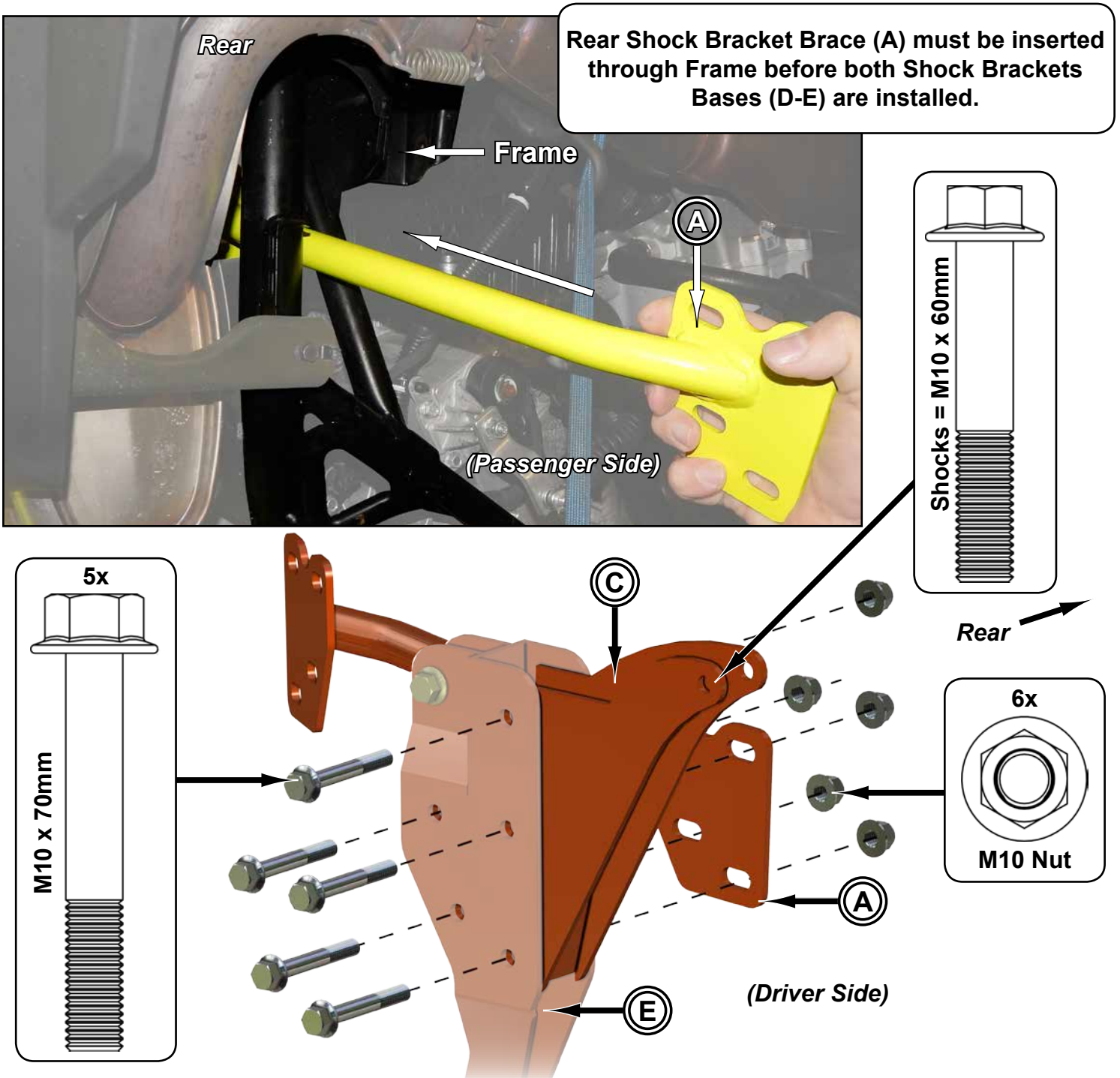

Front Installation: *Do not tighten hardware completely until last step.*

- Install Front Lift Bracket (B) to Shock Mount with hardware shown.
- Reinstall Shocks with stock hardware.

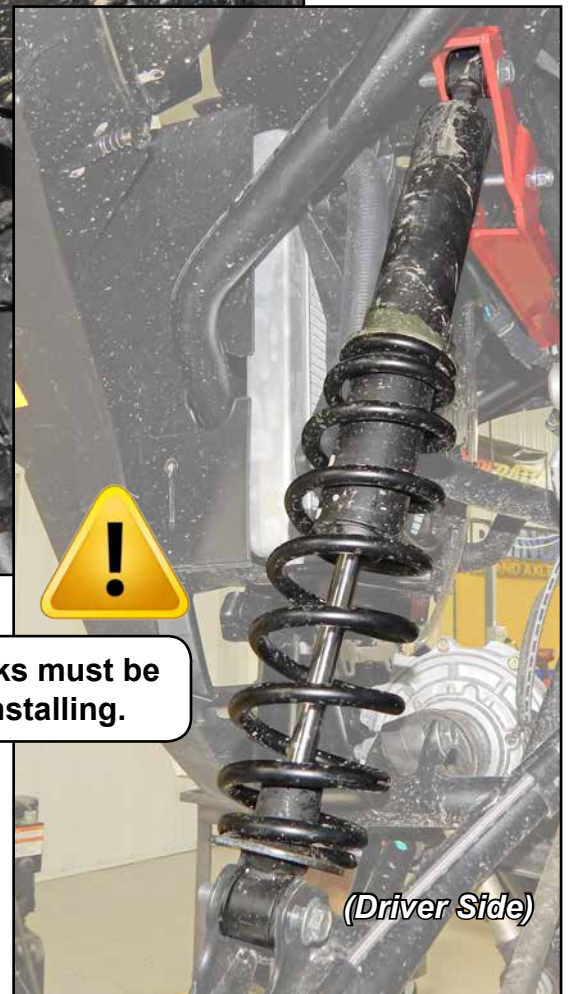
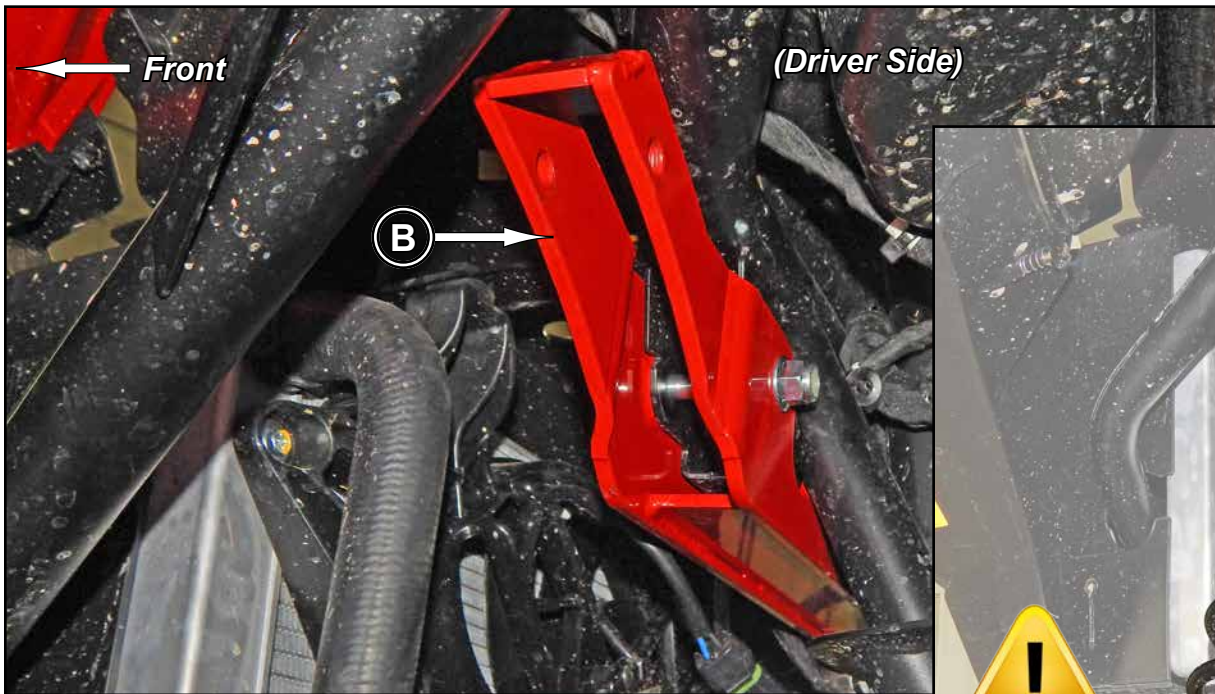
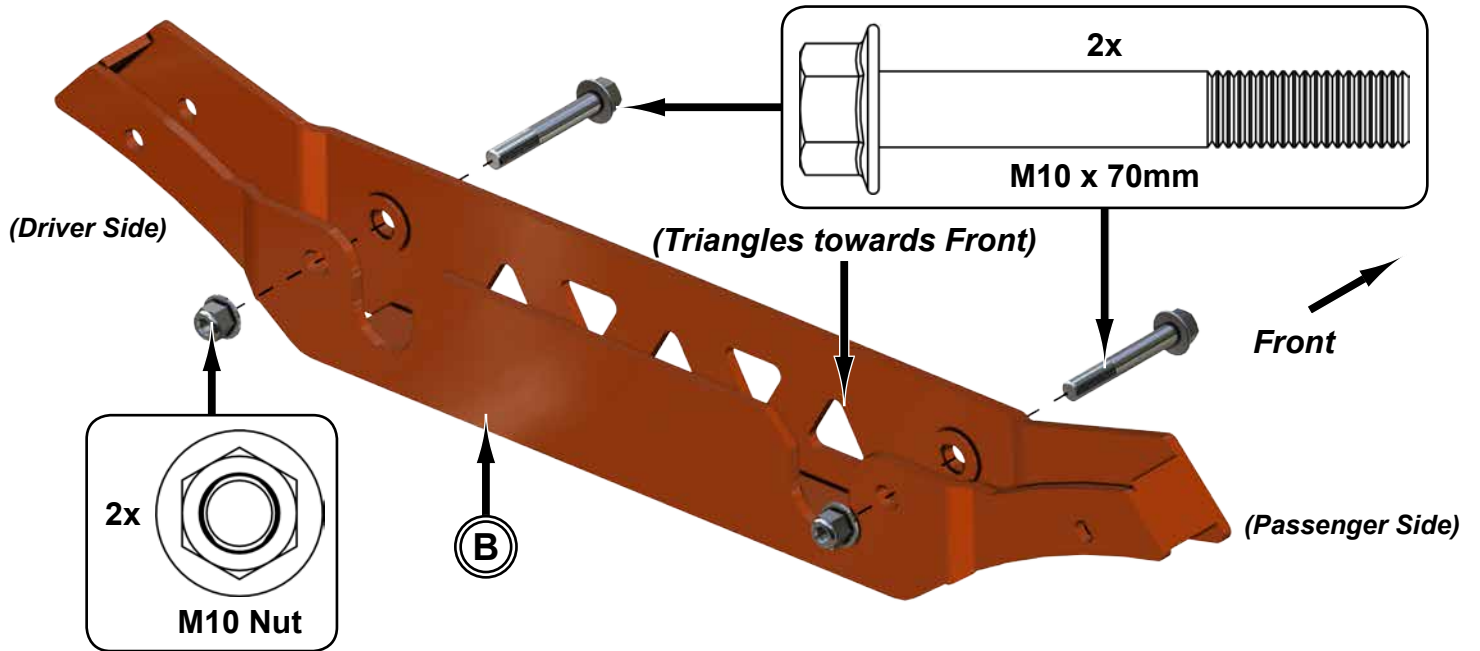

Polaris Front Shocks must be flipped when reinstalling.

Liability Statement

SuperATV's® products are designed to best fit user's ATV/UTV under stock conditions. Adding, modifying, or fabricating any factory or aftermarket parts will void any warranty provided by SuperATV® and is not recommended. SuperATV's® products could interfere with other aftermarket accessories. If user has aftermarket products on machine, contact SuperATV® to verify that they will work together.

Although SuperATV® has thousands of satisfied customers, user should be aware that installing lift kits, long travel, or suspension kits, tires, etc. will change the ride of machine and may increase maintenance and part wear. Operating any off-road machine while, or after, consuming alcohol and/or drugs increases risk of bodily harm or death. No warranty or representation is made as to this product's ability to protect user from severe injury or death. SuperATV® urges operators and occupants to wear a helmet and appropriate riding gear at all times.

By purchasing and installing SuperATV® products, user agrees that should damages occur, SuperATV® will not be held responsible for loss of time, use, labor fees, replacement parts, or freight charges. SuperATV®, nor any 3rd party, will not be held responsible for any direct, indirect, incidental, special, or consequential damages that result from any product purchased from SuperATV®. The total liability of seller to user for all damages, losses, and causes of action, if any, shall not exceed the total purchase price paid for the product that gave rise to the claim.

SuperATV® will warranty only parts provided by SuperATV®. Any damage or problems with OEM housings, bearings, seals, or other manufacturers' products will not be covered by SuperATV®. SuperATV® parts and products are not warrantied if item was not installed properly, misused, or modified.

Installing, adding, modifying, or fabricating any factory or aftermarket product to your ATV/UTV may violate certain local, state, and federal laws. Be advised that laws vary depending on town, city, county, state, etc. Use of certain products on public streets, roads, or highways may be in violation law. The Buyer is solely and exclusively legally and personally responsible for any violation of the law by the installation or use of the product. You must abide by all local, state, and federal laws, including but not limited to vehicle safety, traffic laws, and ordinances. It is your responsibility to know the laws and how they apply to you.

The Buyer is responsible to fully understand the capability and limitations of his/her vehicle according to manufacturer specifications, warnings and instructions and agrees to hold SuperATV® harmless from any damage resulting from failure to adhere to such specifications, warnings and/ or instructions. The Buyer is also responsible to obey all applicable federal, state, and local laws and ordinances when operating his/her vehicle while using this product, and the Buyer agrees to hold SuperATV® harmless from any violation thereof.